



SPEED QUEEN® ON-PREMISES LAUNDRY SOLUTIONS

# Stack Washer/Dryer

LTEE5ASP175TW01, LTGE5ASP115TW01

## Stack Washer/Dryers

Our stack washer/dryers are designed as vertical combinations that provide all of the power of Speed Queen® washers and dryers while occupying only half of the floor space of a conventional washer and dryer setup. Plus, these stacked units allow you to utilize the same connections and hook-ups required by a standard washer and dryer, so you won't have to make changes to your installation.

- ENERGY STAR® Qualified to use less energy, save money and help protect the environment.
- Water use is trimmed to 13.9 gallons per cycle to reduce operating costs.

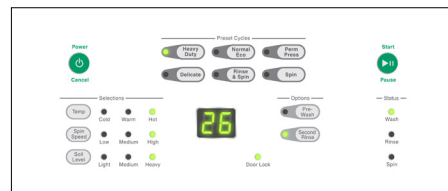

Washer Control

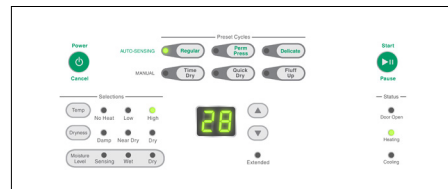

Dryer Control

## Electronic Homestyle Control

Speed Queen® washers and dryers with Electronic Homestyle controls are designed for durability and are easy to operate with intuitive selection buttons and cycle status indicator lights. This control option features a time-remaining display, six preset cycle buttons, cycle adjustability for temperature and load size, soils levels along with additional cycle enhancer options for a pre-wash or second rinse cycle.

# Stack Washer/Dryer

Specifications	
Model	LTEE5ASP175TW01, LTGE5ASP115TW01
Control Option	Electronic Homestyle
Control Location	Front
Capacity - lb (kg)	Washer 21.5 (10) Dryer 18 (8.2)
Cylinder Volume - cu. ft. (liters)	Washer 3.42 (96.8) Dryer 7.0 (198)
Overall Width - in (mm)	26.875 (683)
Overall Depth - in (mm)	27.73 (704)
Overall Height - in (mm)	78.5 (1994)
Spin Speed G-Force -RPM	440 (1200)
Motor Power Consumption - hp (kw)	Washer 0.9 (0.67) Variable Speed Dryer 0.33 (0.25)
Water Consumption Per Cycle - g (l)	13.68 (51.8)
IWF (Water Factor)	4.0 (0.53)
IMEF (Modified Energy Factor)	2.20 (62.3)
Available Heat Sources	Gas or Electric
Available Heating Element (Electric W)	5350 @ 240V
Gas Inlet Connection - in (mm)	3/8 (9.5)
Gas Consumption - BTU/Hr	22,500
Exhaust Outlet DIA. - in (mm)	4 (102)
Exhaust Airflow - cfm (liters/sec)	220 (105)
Available Water Temperatures	3
*Available Cycles	Washer Heavy Duty, Normal Eco, Perm Press, Delicate, Rinse & Spin, Spin Only Dryer Regular, Perm Press, Delicate, Time Dry, Quick Dry, Fluff Up
Water Pressure -PSI (Bar)	20-120 (1.4/8.3)
Cycle Indicator Lights	Yes
Cylinder Finish	Washer Stainless Steel Dryer Galvanized
Available Colors	White
Door Type (Solid/Window)	Window
Available Electrical Requirements - Voltage/Hz/Ph - Circuit Amperage	Washer 120/60/1 - 15 Electric 208/240/60/1 - 30 Gas 120/60/1 - 15
Shipping Dimensions Approx. - in (mm)	Width 30 (762) Depth 34 (864) Height 80 (2032)
Net Weight - lb (kg)	350 (159)
Shipping Weight - lb (kg)	380 (172)
Agency Approvals	Electric cULus Gas cCSAus

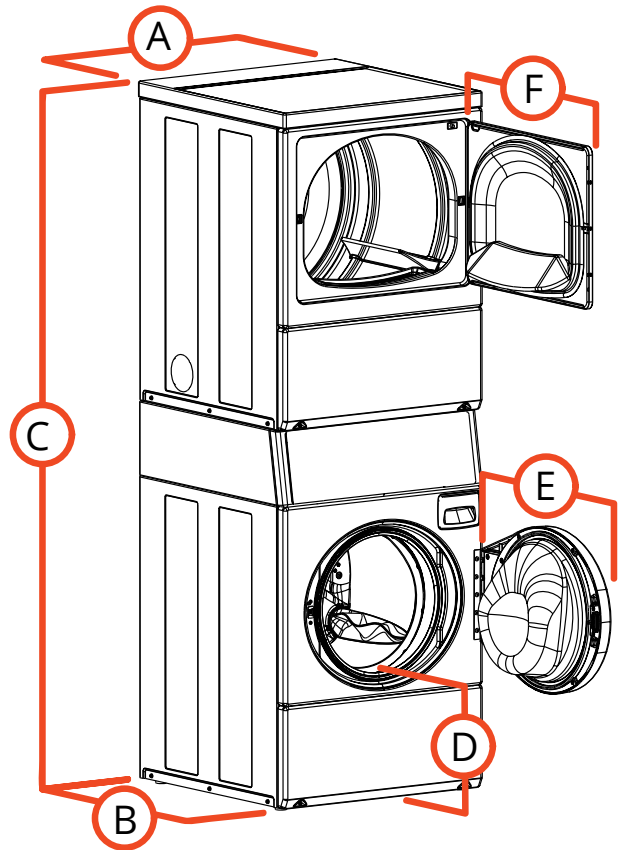

A. Overall Width - in (mm)	26.875 (683)
B. Overall Depth - in (mm)	27.73 (704)
C. Overall Height - in (mm)	78.5 (1994)
D. Floor To Door Opening - in (mm)	14.5 (368)
E. Washer Door Swing - in (mm)	24 (610)
F. Dryer Door Swing - in (mm)	23.5 (597)

ADA Compliant - Lower Unit

Note: Not all options are available for all models. Refer to the price list for the available models and options.

\* Information shown applies to highest end control available.

For the most accurate information, the installation guide should be used for all design and construction purposes. Due to continuous product improvements, design and specifications subject to change without notice. The quality management systems at Alliance Laundry Systems are registered to ISO 9001.